

Item No.	Size	Description
1	-	Lifting Lug (x3)
2	2" FNPT	Hot Water Outlet Port, Coupling
3	1" FNPT	Temp. & Pressure Relief Port, Coupling, MIN. 3" Thermostat Length Required
4	1-1/2" FNPT	Heat Pump Hot Water Return, Port
5	11"x15"	Service Handhole
6	3" FNPT	Cold Water Inlet, Port (x2)
7	1-1/2" FNPT	Heat Pump Cold Water Supply / Tank Drain, Coupling
8	3/4" FNPT	Thermowell, Port (x4; height locations: 20/40/60/80% tank volume)
9	1-1/4" FNPT	Anode, Port (x2); Ships with (2) Magnesium Anodes, 24" Length, Rigid

NOTES:
 Volume: 275 Gal.
 Max. Allowable Working Pressure: 125psi@210°F
 ASME B&P Vessel Code Section IV
 HLW Stamped
 Glass-lined
 2.5" Outdoor Foam Insulation (ASHRAE 90.1b)
 R-value: >16
 Installed Dry Weight: 620 lbs.

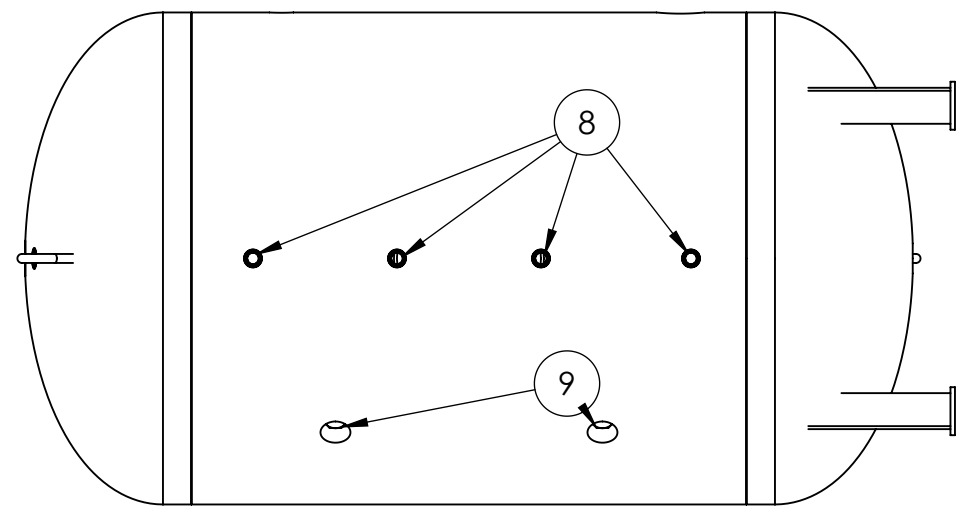
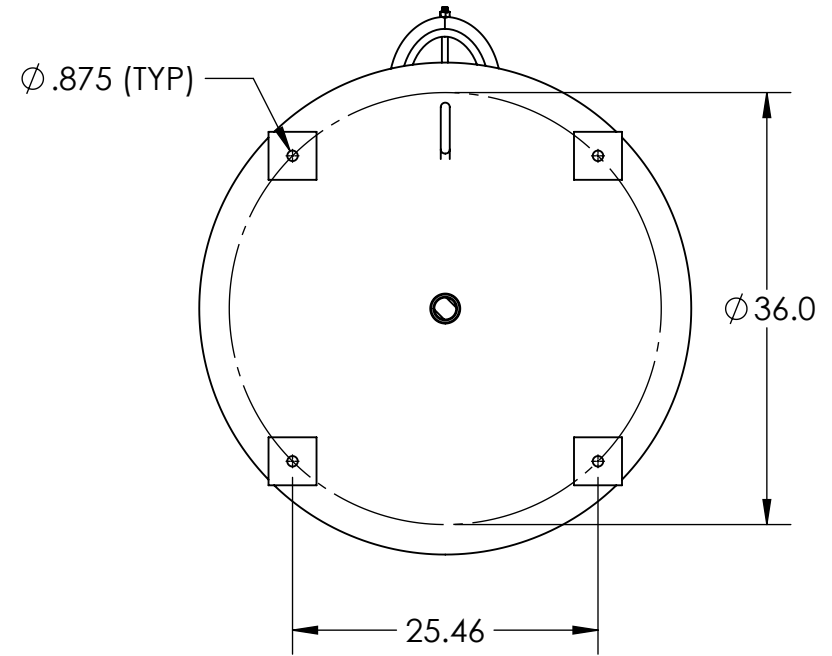
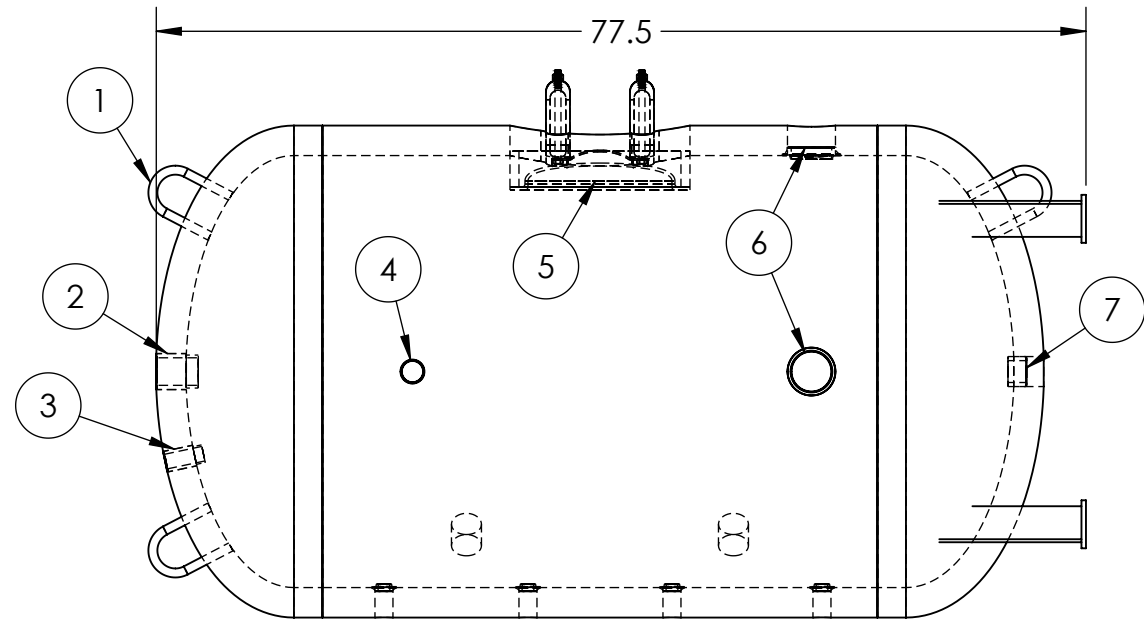
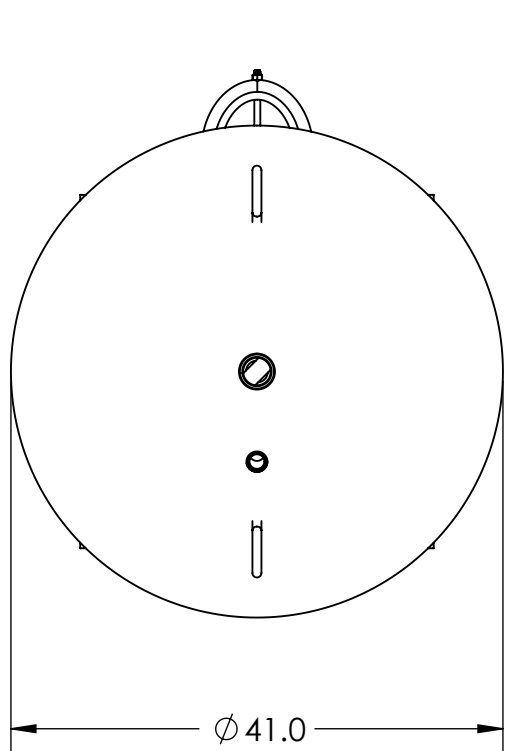

SMALL PLANET SUPPLY		
TUMWATER, WA		
TITLE: WDHRT275 GAL STORAGE TANK (T23000)		
SIZE	DWG. NO.	REV
B	003-00052	A
SCALE: 1:16	⊕	SHEET 1 OF 1

4

3

2

1

B

B

A

A